

DiSEqC Positioner

60 memories

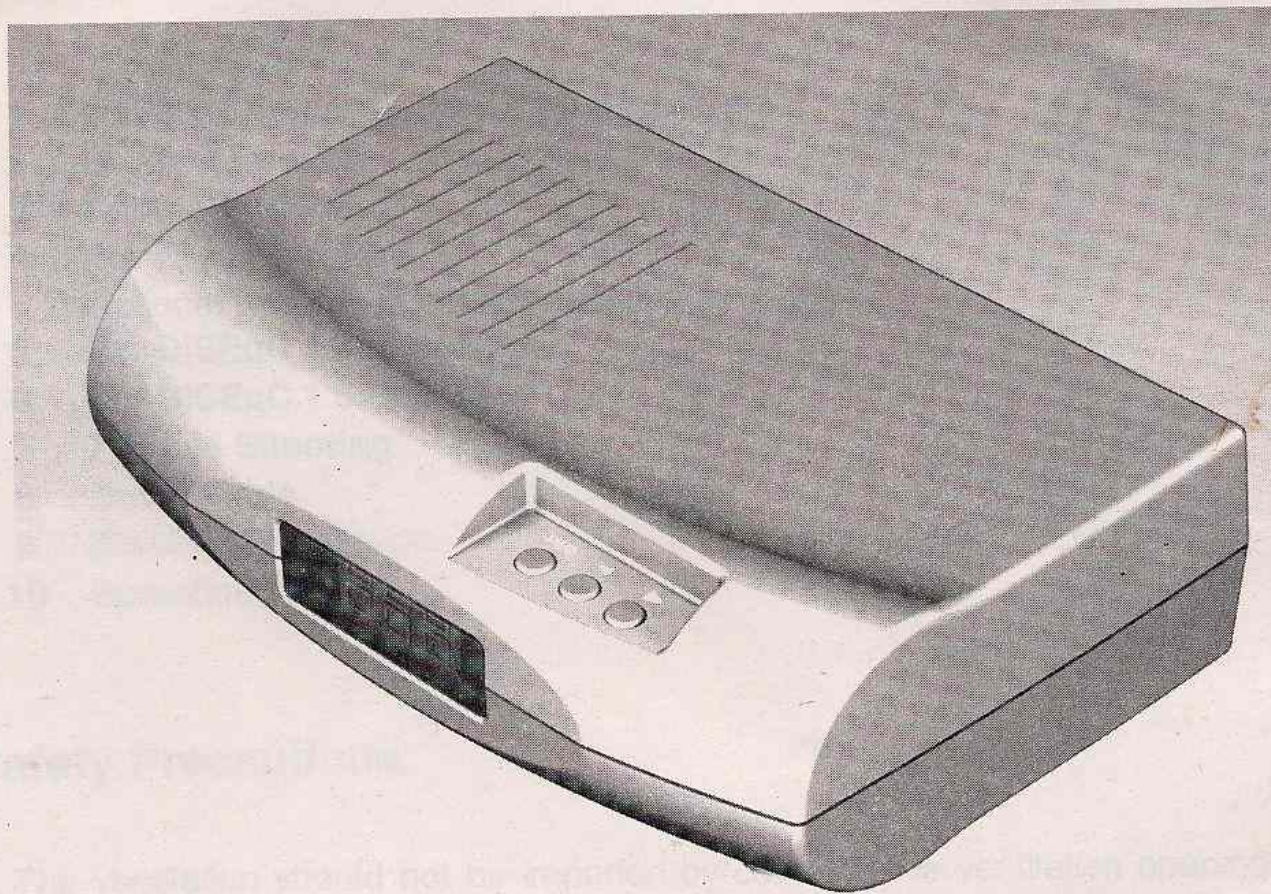

- **DiSEqC 1.0 / 1.2 Receivers Compatible**
- **Work with any Receiver via Optional Remote Control**
- **Compatible with any Actuator or H-H Mount**
- **60 Programmable Memories**
- **Easy Operation and Quick Installation**
- **Fine-tune Function for Better Reception**
- **Anti-Noise Circuit to avoid miscounting**
- **Short Circuit and Overload Protection**
- **Software Limits Protection**
- **Auto Turn-off Function**
- **Re-Calculate (Adjust Shift) Function**
- **Lock Key Protection**

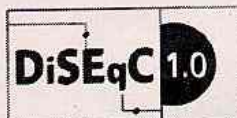

❖ Content

	Page
1 Optional Remote Control v.s. Receiver	P1
2 Basic Operation	P2
3 Cable Connection	P3
4 For any Receiver	P4
Optional Remote Control is necessary	
5 For DiSEqC 1.2 Receiver	P7
6 For DiSEqC 1.0 Receiver	P9
7 Trouble Shooting	P10
8 Quick Table	P11
9 Display Description	P12
10 Specification	P12

Safety Precautions

1. The ventilation should not be impeded by covering the ventilation openings with items, such as newspapers, table-cloths, curtains, etc.
2. No naked flame sources, such as lighted candles, should be placed on the apparatus.
3. The apparatus shall not be exposed to dripping or splashing and no objects filled with liquids, such as vases, shall be placed on the apparatus



The DiSEqC™ is a trademark of EUTELSAT.

❖ Optional Remote Control v.s. Receiver

Do you need the optional remote control? It is upon your receiver and how many positions you want. Please check the following table.

Receiver Type	Remote Control	Positions	Note
DiSEqC 1.2	Not Necessary	60	Fully controlled by receiver.
	Yes / Optional	60	Controlled by receiver or optional remote control.
DiSEqC 1.0	No	4	Controlled by receiver.
	Yes / Optional	60	Controlled by receiver or optional remote control.
No DiSEqC	Yes / Necessary	60	Just like stand-alone positioner.

Remote Control

Optional for Receiver without DiSEqC !!!

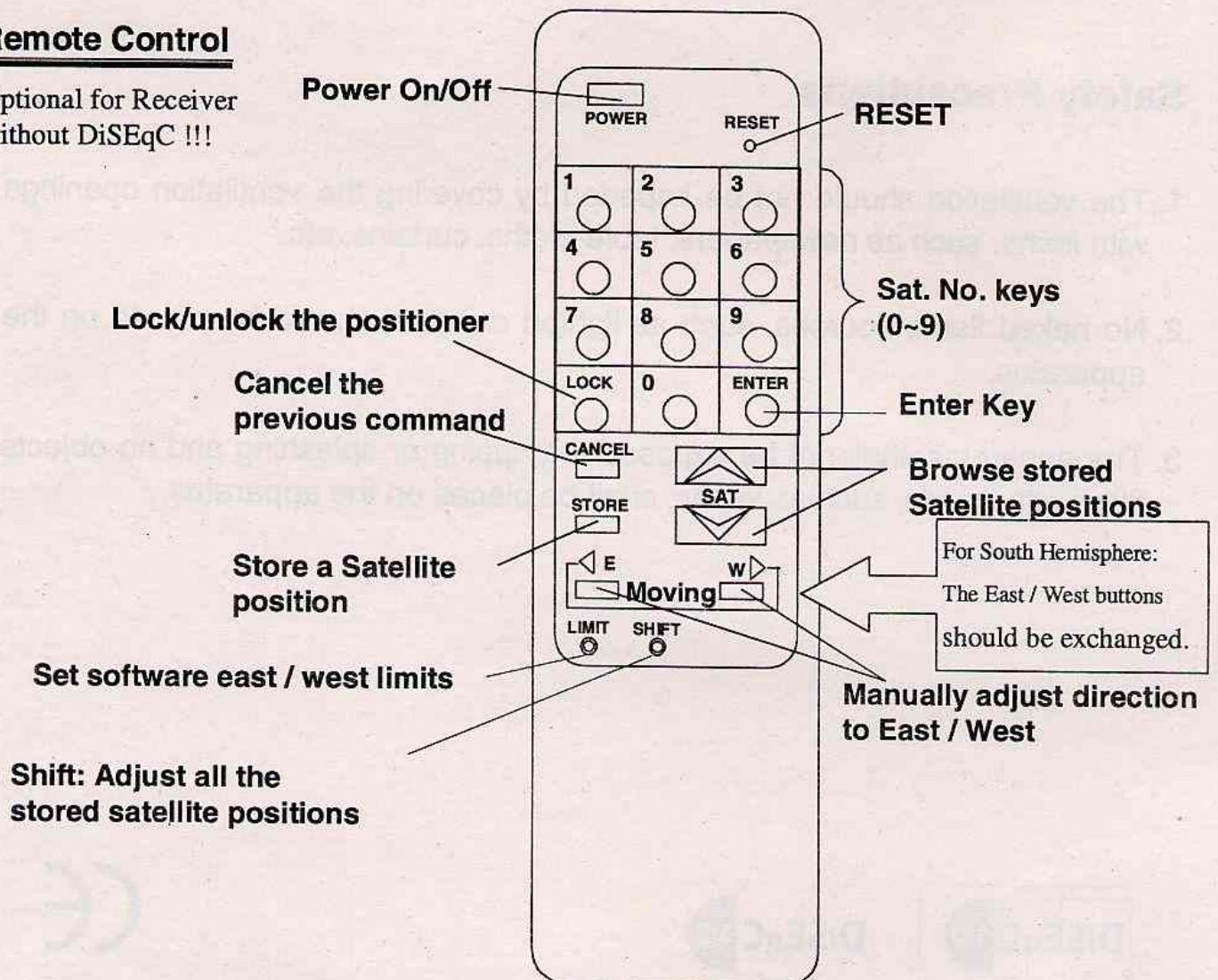

❖ Basic Operation

Front View

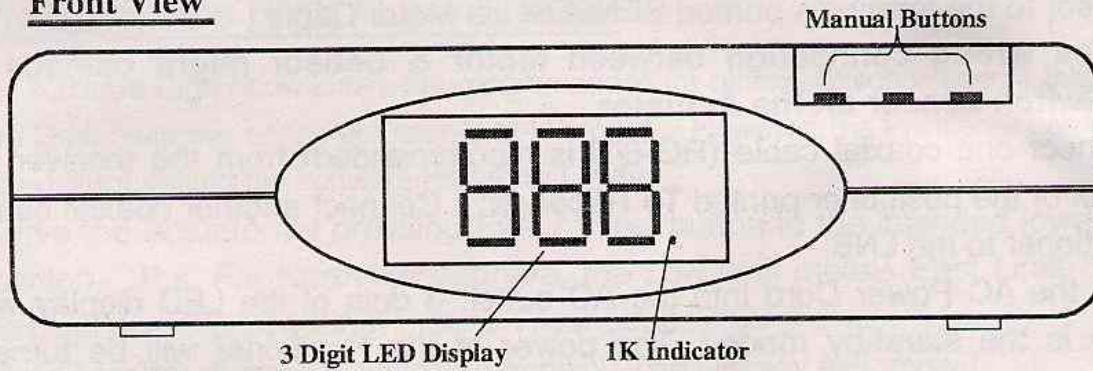

Back View

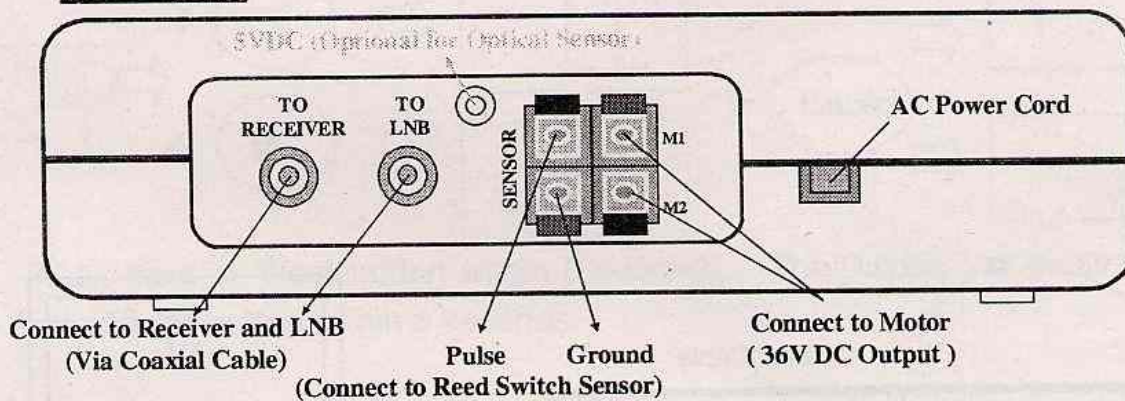

Manual Buttons

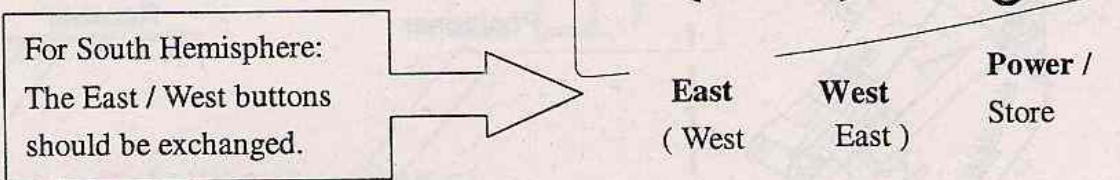

* 3 Digits LED Display

1. The total **antenna position Index** (pulse counts) is 2,000 (0~1,999).
2. For Index 0~999, the lower right dot (1K Indicator) will not light on.
3. For Index 1,000~1,999, the lower right dot (1K Indicator) will light on.

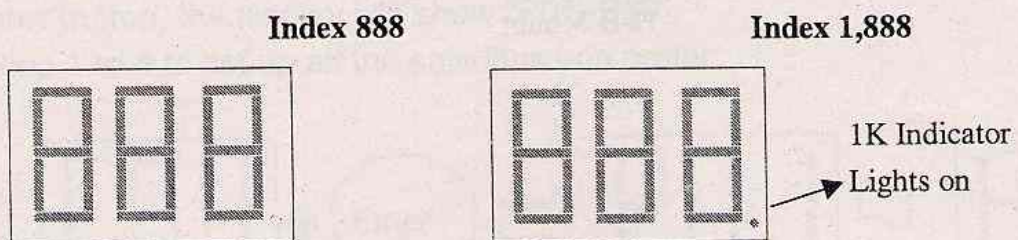

❖ Cable Connection

1. Connect the Motor to the terminals printed **M1** & **M2**, and connect the Reed Switch Sensor to the terminals printed **SENSOR** via Motor Cable.
p.s.: **The wrong connection between Motor & Sensor might damage the Reed Switch Sensor on the Actuator.**
2. Connect one coaxial cable (RG-6/U is recommended) from the receiver to the rear panel of the positioner printed **To Receiver**. Connect another coaxial cable from the positioner to the LNB.
3. Plug the AC Power Cord into the AC outlet. 3 dots of the LED display will light on. Now is the stand-by mode. The power of the Positioner will be turned on / off automatically while the LNB power of receiver is turned on / off.

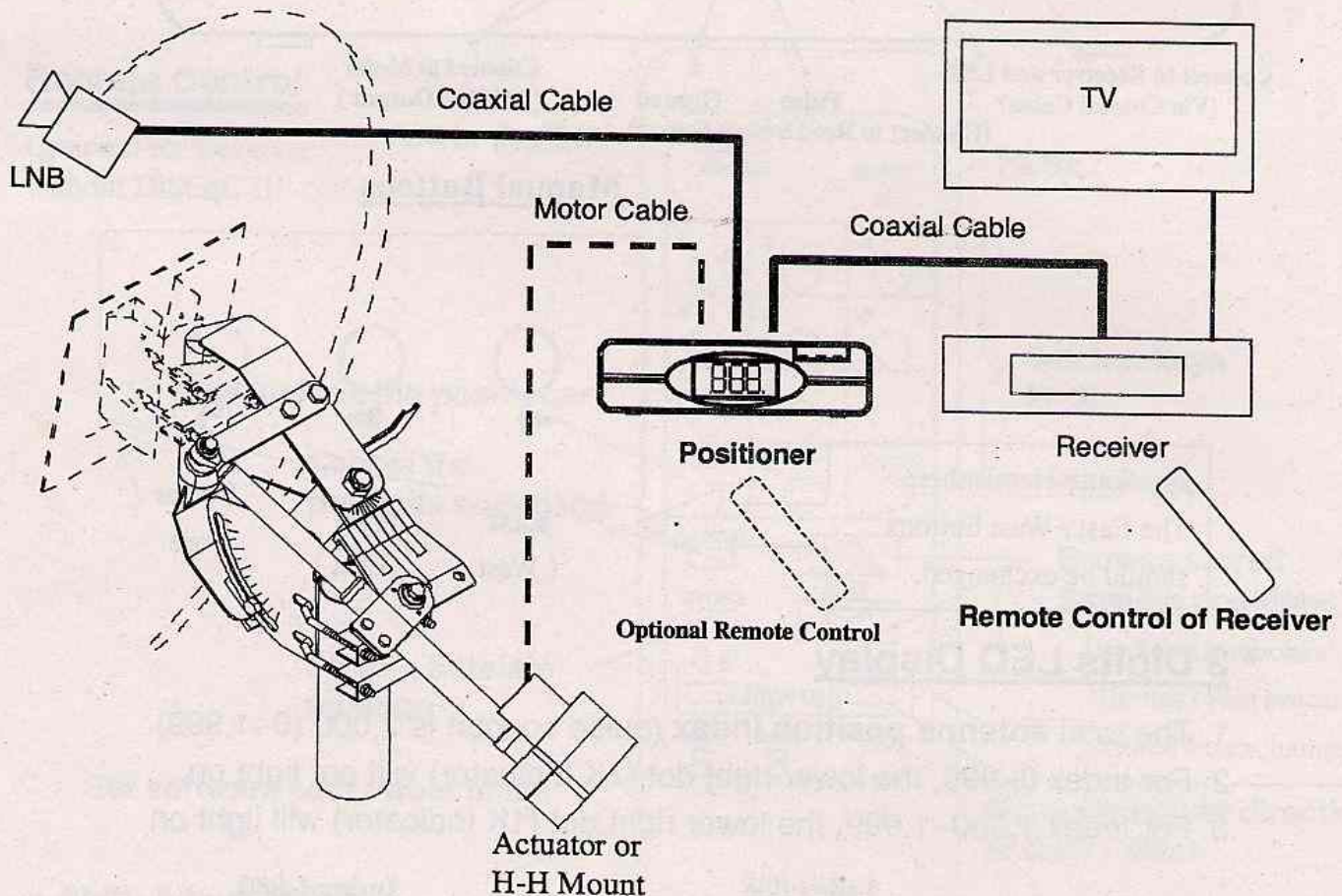

❖ **For any Receiver** Optional Remote Control is necessary

* **Set the Software High / Low Limits:**

Setting the software High / Low Limits are recommended for better protection even if there are Hardware Limit Switches on the actuator or H-H mount. However, the Positioner can be operated **without** setting the software High/Low Limits.

1. Drive the Actuator by pressing East / West button to the intended lowest / highest position. P.s. For North Hemisphere, the Low limit means East Limit. For South Hemisphere, the Low Limit means West Limit.
2. Prod **Limit** button on the remote control. The Display will show L_ _.

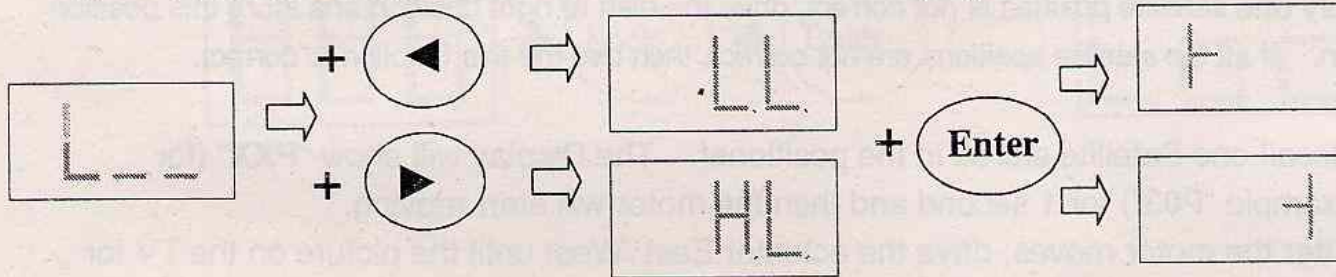

3. Press **East** or **West** button within 3 seconds. The Display will show L.L. or H.L. Press **Enter** button within 3 seconds.

* **Cancel the Software High / Low Limits:**

Prod the **Limit** button on the remote control twice, the display will show "L_ _" first then flashy "LoF", press the **Enter** button within 4 seconds to cancel the limits.

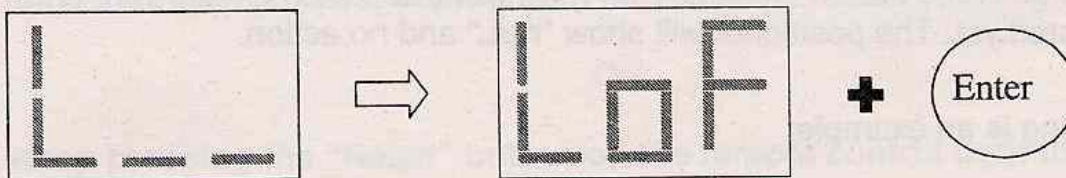

* **Store the Satellite Positions:**

1. Drive the Actuator or H-H mount East / West until the picture on the TV screen is clear.
2. Press **Store** button on the remote control. The Display will show "C_ _".
3. Press no. buttons "1~60" the display will show "C01~C60".
4. Press **Enter** button, the display will show "P01~P60".
5. Repeat Step 1 to 4 to set up all the satellites you prefer.

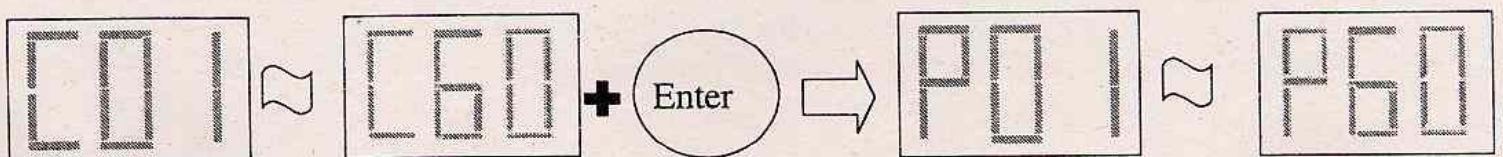

* Recall a Satellite Position:

1. Simply press **Sat A** or **Sat V** button to browse

OR

2. Input specific position number **1~60** on the remote control and press **Enter** button within 3 seconds, the positioner will drive the actuator to the intended position.

p.s. If the position has not been stored yet, the positioner will ignore this command.

* Re-calculate (Adjust Shift) Function:

If **only one** satellite position is not correct, drive the dish to right position and store this position again. If **all** the satellite positions are not correct, then use the this function to correct.

1. Recall one Satellite stored in the positioner. The Display will show "**PXX**" (for example "**P03**") for 1 second and then the motor will start moving.

2. After the motor moves, drive the actuator East /West until the picture on the TV for this Satellite is clear for "**P03**".

3. Prod the **Shift** button on the remote control, after the display shows "**ShF**" press **Enter** button within 4 seconds. If set successfully, the Display will show "**PXX**" again (for example "**P03**"). All positions are shifted to right angle again.

Notice: If step 1. is skipped, the new antenna position will be shifted to **P01**. If P01 has not been stored yet. The positioner will show "**nuL**" and no action.

The following is an example:

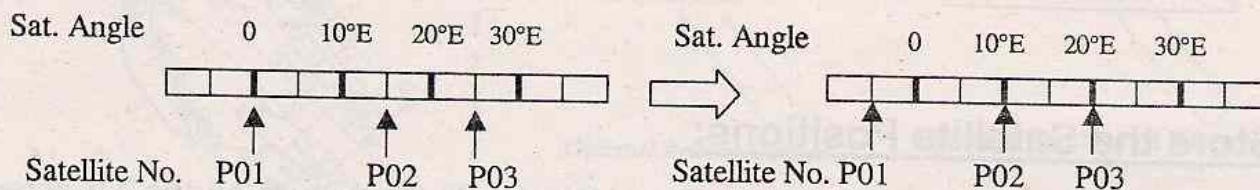

* Lock Key Protection:

LOCK mode is a feature that avoids any trigger on the remote control without purpose or in error.

1. To enter LOCK MODE, press **Lock** key on remote control and then press **Enter** button in 2~3 seconds to lock the positioner.
The display will show "Loc" after blinking, and all the other functions cannot be triggered **except power on/off, and DiSEqC commands from receiver.**
2. To unlock, press **Lock** key with following **Enter** button again to unlock the positioner.

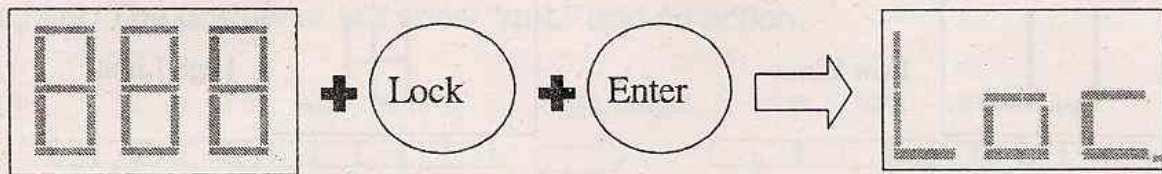

* Restore Factory Default (Reset):

This function will clear all data in the Positioner, includes High/Low Limits, Satellite Positions, ..., etc.

1. **Unplug from the AC outlet. Press the Power button on the top of the positioner and re-plug to the AC outlet. Keep pressing the Power button for 3 seconds. The Display will show 10, 9 ... 1, then reset the system. To stop the Reset process, unplug from the AC outlet before counting to 1.**

OR

2. **Keep pressing the "Reset" button on the remote control until the positioner finishes counting down from 10 to 1. To stop the Reset process, simply stop pressing the Reset button before the positioner counts down to 1. If reset has been successfully completed, it will show "———" on the LED. After 2 seconds, it shows 000. (count number 1000).**

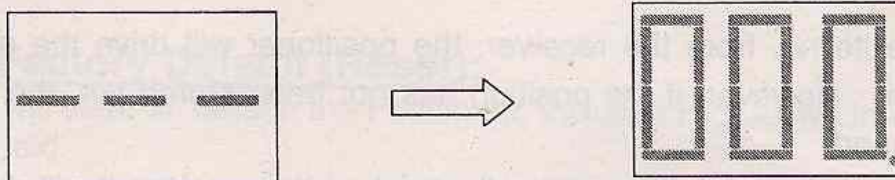

❖ For DiSEqC 1.2 Receiver

The denomination of some commands might be different, but similar. Please refer to the manual of the Receiver.

* Set the Software High / Low Limits:

After sending the commands from the DiSEqC 1.2 receiver, the Display of the positioner will show as below:

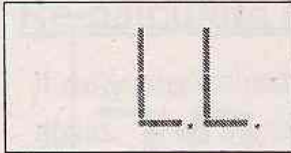

Low Limit

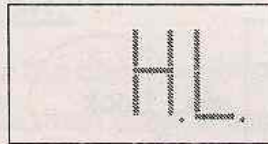

High Limit

	Low Limit	High Limit
North Hemisphere	East Limit	West Limit
South Hemisphere	West Limit	East Limit

* Cancel the Software High / Low Limits:

After sending the command from the DiSEqC 1.2 receiver, the Display of the positioner will show "LoF".

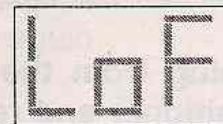

* Store the Satellite Positions:

1. Drive the Actuator East / West until the picture on the TV screen is clear.
2. Choose a sat. no. 1 ~60 and then send **Store** command from the receiver.
3. The Display will show "C01~C60" then show "P01~P60".

Repeat Step 1 to 3 to set up all the satellites you prefer.

* Recall a Satellite Position:

Change the satellite no. from the receiver, the positioner will drive the actuator to the intended position. However, if the position has not been stored yet, the positioner will ignore the command.

Note: If the Channels and Satellites are well preset on the receiver, it will drive the actuator to the right position while user changes the Channels. After arriving the right position, the Display will show the Satellite no. as "P01" ~"P60".

* Re-calculate (Adjust Shift) Function:

1. Recall one Satellite position stored in the positioner. The Display will show "PXX" (for example "P03") for 1 second and then the motor will start moving.
2. After the motor moves, drive the actuator East /West until the picture on the TV for this Satellite is clear for "P03".
3. Send **Shift** command (or re-calculate) from the DiSEqC 1.2 receiver.
4. After setting successfully, the Display will show "PXX" again (for example "P03"). The position PXX is shift to a new position.

Notice: If step 1. is skipped, the new antenna position will be shifted to **P01**. If P01 has not been stored yet. The positioner will show "nuL" and no action.

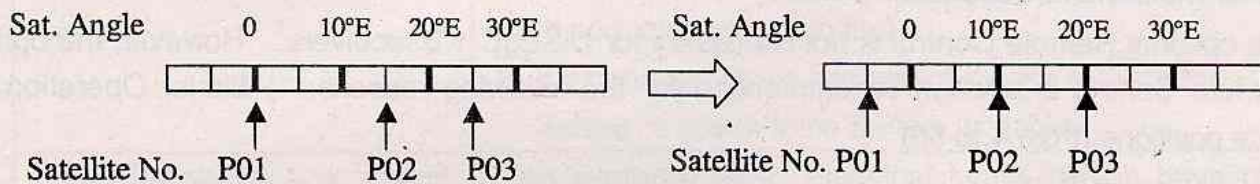

* Go to the mechanical Position 0 (Operate by Receiver only):

1. **Before using this function, please make sure the mechanical limit switches of the actuator or H-H mount are well adjusted in order to avoid any damage or injury.**
2. Send "reset" or "Goto 0" command from the receiver. The positioner will drive the motor toward East. If the motor goes to the wrong direction, just reverse the 2 wires connecting currently to **M1** & **M2** on the positioner. The position index on the LED display will be decreased until the motor stops due to the mechanical limit switch, then the Display will show "Er2" first then "000" which indicates the mechanical 0 position of the Actuator.

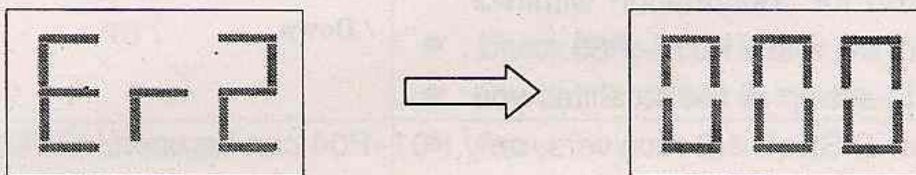

* Restore Factory Default (Reset):

This function will clear all data in the Positioner, includes High/Low Limits, Satellite Positions, ..., etc.

Unplug from the AC outlet. Press the Power button on the top of the positioner and re-plug to the AC outlet. Keep pressing the Power button for 3 seconds. The Display will show 10, 9 ... 1, then reset the system. To stop the Reset process, unplug from the AC outlet before counting to 1.

❖ For DiSEqC 1.0 Receiver

1. For DiSEqC 1.0 Receivers, they can control up to 4 positions.

Position	1	2	3	4
LNB	1	2	3	4
LNB	A	B	C	D

The table is for your reference only. The operation might be different for different receivers. For example, some receivers call position 1 ~ 4 as **LNB1, 2, 3, 4** or **DiSEqC A, B, C, D**. Please refer to the manual of your receivers.

- In order to avoid confusion, the positioner will ignore the DiSEqC 1.0 commands after receive the DiSEqC 1.2 commands. It can recognize the DiSEqC 1.0 commands again after unplug from AC for more than 5 seconds.
- The optional Remote Control is not necessary for DiSEqC 1.0 receivers. However, the optional Remote Control is strongly recommended for the following reasons: 1) Easier Operation. 2) More positions (from 4 to 60).

The following is the operation without remote control. If you have the optional remote control, please refer to chapter ❖ **For any Receiver**

* Store the Satellite Positions: Operate via the 3 Manual buttons

- Drive the Actuator East / West via the manual East / West until the picture on the TV screen is clear.
- Press the Power / Store button for 5 seconds, the LED will show "C01".
- Press Up / Down buttons to choose the sat. no. you want to store: C01~C60.
- Press Store button for confirmation within 3 seconds, the LED will show P01 ~ P60.

Repeat Step 1 to 3 to set up all the satellites you prefer. However, for DiSEqC 1.0 receivers, only P01~P04 can be used.

Manual Buttons

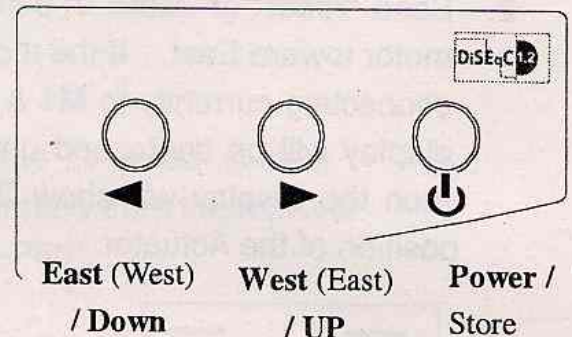

* Recall a Satellite Position:

Change the DiSEqC 1.0 setting of the channels. The positioner will drive the dish to the right Satellites while you change the channel. The Display will show "P01" ~ "P04"

* Restore Factory Default (Reset):

This function will clear all data in the Positioner, includes High/Low Limits, Satellite Positions, ..., etc.

Unplug from the AC outlet. Press the Power button on the top of the positioner and re-plug to the AC outlet. Keep pressing the Power button for 3 seconds. The Display will show 10, 9 ... 1, then reset the system. **To stop the Reset process, unplug from the AC outlet before counting to 1.**

❖ Troubleshooting

Symptoms	Check points
Can't work with DiSEqC 1.0 Receiver	<ol style="list-style-type: none"> 1. Make sure position no.1 to 4 are stored. 2. After receive DiSEqC 1.2 commands, the DiSEqC 1.0 commands will be ignored. Please operate the positioner by DiSEqC 1.2 receiver, which is much better for motorization system.
Can't move to count less than 0 or more than 999.	<p>The total position index of this Positioner is 2000 (0~1999), which is enough for most of the application. Use "<u>Goto Position 0</u>" Function to solve.</p>
The Stored Positions are not correct.	<ol style="list-style-type: none"> 1. Try to use the "<u>Re-calculate(Adjust Shift) function</u>" to correct the position first. 2. If it happens again and again, please replace the Reed Sensor to check if the Sensor is stable.
The LED shows l- or -l, and can't move more.	<p>The symbols mean Electrical Limits, which have been set. If you want to cancel this setting, use the "Limit Off Function" from the receiver. And set the software limit again.</p>
Er1 Message (Over Current) Or System Shut-down	<ul style="list-style-type: none"> ● Make sure there is no short-circuit of the wire connection. ● Check if the Antenna is blocked by anything. ● Make sure the Motor works well. Some times a malfunction Motor can cause higher current. ● Maybe the Antenna is too heavy. Please try to use our high-power version.
Er2 Message (No Pulses)	<ul style="list-style-type: none"> ● Re-check the wire connection. ● Make sure the actuator is not stopped by Mechanical Limit. ● Check if the Reed Switch Sensor is broken. ● Check if the Motor is broken.
Er3 / Er4 Message (Internal Error)	<ul style="list-style-type: none"> ● Reset the positioner.
Only the LED lights on and the Positioner doesn't work. (No response)	<ul style="list-style-type: none"> ● Unplug the AC Power Cord from the AC outlet. Wait for more than 10 seconds then re-plug. ● This problem might be caused by the unstable AC power. In order to protect the stored data, the Positioner will lock itself under this situation. A voltage regulator might help.
Turn-Off Automatically	<p>The Display will be turned-off while LNB power is off.</p>
Can't be Turned-off by optional Remote Control or manual Power button.	<p>If the LNB power of receiver is switched-on, the positioner can't be turned-off.</p>

❖ Quick Table for Optional Remote Control

○ Key on Remote Control

● Button on Positioner

Power ON/OFF: Power or ⏻

Manual East/West: ◀ E or W ▶ or ◀ or ▶

Set Software Limit: ◀ E or W ▶ to intended Lo/Hi position, + Limit + ◀ E or W ▶ + Enter

Cancel Software Limit: Limit + Limit + Enter

Store Satellite Positions: ◀ E or W ▶ to the Position you want, press Store
then Input Sat. No. 1 ~ 60 + Enter

Recall a stored position (1) SAT ▲ or SAT ▼
(2) Press Sat. No. key 1 ~ 60 + Enter

Shift Function: Recall a stored position 1-60 + ◀ E or W ▶ to better position
+ Shift then LED shows "ShF", + Enter then LED shows P01~P60

Reset : Keep pressing Reset for **10 seconds**. The actuator will retract fully and the software limits will be canceled.

Interruption: Press Cancel to **STOP** the Motor.

Lock key protection: press LOCK + Enter to lock the positioner and again to unlock it.

❖ Display Description

	Standby mode.		Enter Limit Setting mode..
	Pulse "000".		Cancel software limits.
	Pulse "1000" (dot means 1K).		Reach to software low limit.
~	Satellite position in storing process.		Reach to software high limit.
~	Satellite position 01~60.		Re-Calculation (adjust shift) function.
	Error message: overload.		Invalid execution of Re-Calculation function.
	Error message: no feedback from sensor or reach to hardware limits.		Lock key protection
	Setting software high limit.		Flashy display after successful resetting the positioner.
	Setting software low limit.		

❖ Specification

Input Voltage	:	220-240VAC 50Hz (110VAC 60Hz Available) 13 / 18 VDC (F Type via Coaxial Cable)
Output Voltage	:	13 / 18 VDC (F Type / According to the Input) 36VDC (via Motor Cable) 5VDC (Optional for Optical Sensor)
Maximum Current	:	2.2A / 3.5A (High Power Version)
Power Consumption	:	Standby: 5W Max. : 70W / 100W (High Power Version)
Position Memories	:	60 / 4
Protocol	:	DiSEqC 1.2 / 1.0
Remote Control	:	IR (Optional)
Operating Temperature	:	5°C to 40°C (41°F to 104°F)
Storage Temperature	:	-20°C to 60°C (-4°F to 140°F)
Dimensions (WxHxD)	:	230x70x158 mm ³ (Net) / 270x76x190 mm ³ (Gross)
Weight	:	1.2 Kg(Net)/1.3Kg(Gross) (+0.3Kg for High Power version)

All Specification might be changed without prior notice.

PN9211-1